

Monitoring System For Vehicle Emissions With Prediction Of Pollution Absorption By Plants In IT Telkom Surabaya Parking Area

1st Deny Satria Ardi
Faculty of Information Technology and
Business
Institut Teknologi Telkom Surabaya
Surabaya, Indonesia
rafidw@student.ittelkom-sby.ac.id

2nd Khodijah Amiroh
Faculty of Information Technology and
Business
Institut Teknologi Telkom Surabaya
Surabaya, Indonesia
dijaamirah@ittelkom-sby.ac.id

3th Moh. Hamim Zajuli Al Faroby
Faculty of Information Technology and
Business
Institut Teknologi Telkom Surabaya
Surabaya, Indonesia
alfaroby@ittelkom-sby.ac.id

Abstract— This research examines the increase in vehicle exhaust emissions at the IT Telkom Surabaya Campus along with the increase in the number of students and vehicles. In an effort to reduce air pollution, this research focuses on utilizing Internet of Things (IoT) technology to monitor CO₂ emissions and predict CO₂ absorption by plants in the campus area. The IoT-based tool uses MQ135 sensors and Wemos D1 R2 to detect and send emission data to a cloud platform. The research involved collecting data on CO₂ absorption by trees in the campus environment. The results showed that the IoT-based CO₂ monitoring tool successfully monitored vehicle emissions for five active working days. Although the variety of plant species in the parking lot area is still low, the green open space has been effective in reducing CO₂ emissions and has a positive impact on reducing air pollution. Although there is a gap between CO₂ emissions and plant absorption, green open space still makes a positive contribution in mitigating the impact of CO₂ gas.

Keywords—Antares, CO₂, IoT, MQ135, Wemos D1 R2.

I. INTRODUCTION

Air pollution has become a serious issue in many major cities in Indonesia, mainly due to the growth of industries and motor vehicles that is not balanced with sufficient green spaces [1]. Surabaya, as one of the largest cities in Indonesia, faces similar challenges in dealing with high industrial activities, including the education sector [2]. In educational environments like IT Telkom Surabaya, the growth of the student population and motor vehicles can have a negative impact on air quality through emissions of gases such as CO₂, CO, NO, and HC [3], which pose health risks to students.

This research focuses on the impact of motor vehicles as the primary contributor to air pollution in IT Telkom Surabaya, especially with the growth of students that can lead to an increase in vehicle usage by 20-40% annually. The aim of this research is to support the monitoring and management of the campus environment by utilizing an Internet of Things (IoT) based CO₂ gas monitoring system. The research aims to integrate the MQ-135 gas sensor with Wemos D1 R2, creating 6 development board units to be placed in various parking areas across the campus. Measurement data will be uploaded to the Antares IoT cloud platform and analyzed using a predictive program for plant CO₂ absorption.

Gas sensors such as MQ-135, TGS-2600, MH-Z19B, MG-811, and CCS811 have been used in similar research to detect and measure CO₂ concentration in the air [3]. These sensors are sensitive to CO₂ and can provide accurate measurement results. The implementation of IoT and prediction systems in this research combines the MQ-135 sensor with Wemos D1 R2 to measure CO₂, upload data to the Antares cloud platform, and analyze the data to evaluate the effectiveness of green spaces in neutralizing air pollution.

This research is expected to provide a deeper understanding of air quality in the parking environment of IT Telkom Surabaya and to assess the effectiveness of green spaces in reducing pollution. The results of the analysis can assist in decision-making related to the management and development of green spaces in the future. Through these efforts, it is hoped that this research will contribute to maintaining air quality and the environment at IT Telkom Surabaya.

II. METHODS

A. Research Procedures

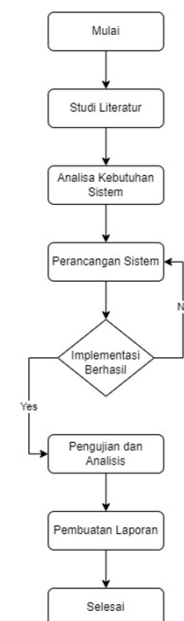

Figure II. Methodology Scheme

In this research, several stages need to be carried out to achieve the intended goals. Each stage of this final project research begins with a literature review aimed at gathering fundamental theories related to the research topic, identifying necessary terminology, and collecting information from books, journals, and websites that align with the research title.

Next, the system requirements analysis stage follows to determine the exact components needed for the research to achieve optimal and efficient results. Subsequently, the system design phase comes into play, involving the design of components with the necessary features so that the system can operate as intended.

Moving forward, the implementation stage focuses on bringing to life the design outcomes from the previous phase. The system testing phase aims to assess the extent of success of the IoT-based air emission monitoring and prediction system. This testing involves both hardware and software elements.

Proceeding to the data analysis stage, the collected data is processed by the analysis program with python in Google Collaboratory to determine the CO2 absorption load that needs to be carried out by plants. This analysis ultimately provides insight into whether the existing green spaces are working optimally to neutralize the air environment at IT Telkom Surabaya. The sequence of formulas used for analysis is as follows:

1) Tree Density

$$\rho = \frac{A}{N}$$

ρ : Kerapatan pohon dalam area.
 A : Luas area di mana pohon-pohon tertanam.
 N : Jumlah pohon dalam area.

2) Species Diversity Index

$$H' = \sum_{i=1}^n \frac{n_i}{N} \log \frac{n_i}{N}$$

H' : Indeks keanekaragaman Shannon-Wiener
 n_i : Jumlah individu ke-i
 N : Jumlah seluruh individu

3) Tree CO2 Absorption Calculation

$$a = \sum_{i=1}^3 b_i c_i$$

a : Laju serapan CO₂ ($\frac{g}{jam}$)

b_i : Jenis Pohon

c_i : Daya serap CO₂

4) Calculation of Residual CO2 Emissions

$$d = \bar{X} - a$$

d : Sisa daya serap CO₂ ($\frac{g}{jam}$)

\bar{X} : Rata-rata CO₂ perjam

a : Laju serapan CO₂ ($\frac{g}{jam}$)

5) Green Open Space Adequacy Estimation

$$\bar{x} - t_{\frac{\alpha}{2}} \frac{s}{\sqrt{n}} < \mu < \bar{x} + t_{\frac{\alpha}{2}} \frac{s}{\sqrt{n}}$$

dimana,

\bar{x} = rata-rata hitung sampel

μ = rata-rata hitung populasi

s = varian sampel

n = jumlah atau ukuran sampel

t = derajat kebebasan

In the final stages, a report is generated containing the analysis results derived from the monitored data and the estimated outcomes obtained from the utilized program.

B. Diagram Block

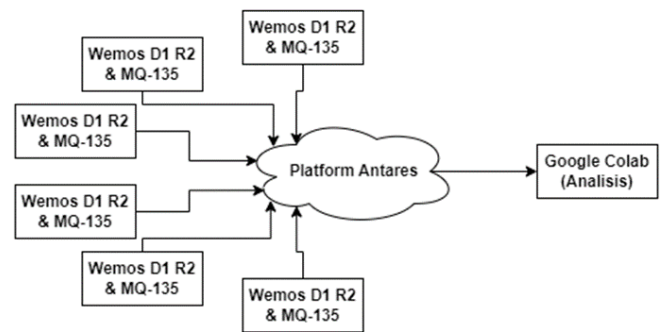

Figure III. Diagram Block System

In this design, a configuration of input-output pins for hardware components is established, followed by the creation of a model for a vehicle exhaust gas emission monitoring device in the air. In this research, the hardware system to be developed encompasses six input results through six MQ-135 sensors positioned at various points in the parking area to directly monitor the CO₂ gas emission levels. The researcher employs the Wemos D1 R2

microcontroller, programmed through the Arduino IDE. The monitoring results are then sent directly to the cloud, subsequently processed using a program containing the aforementioned five formulas, which will yield an output in the form of an estimation of the adequacy of the existing green open spaces in the IT Telkom Surabaya parking area.

C. Hardware Design

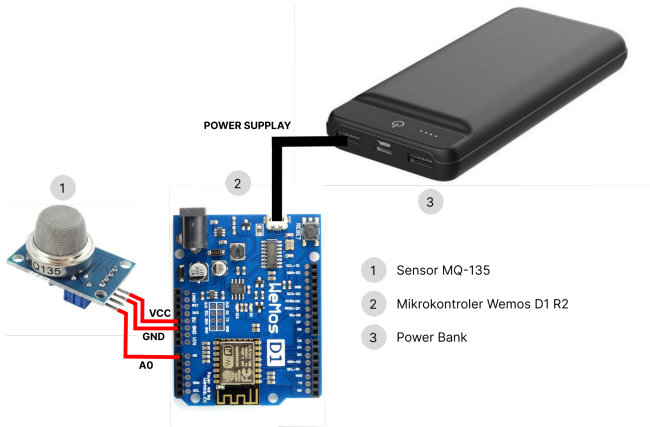

Figure II. Hardware Design System

The design of this electronic device is carried out by integrating all the hardware components used to ensure they function according to the designed system and can be connected through both serial and wireless connections. The design results can be seen in the above image. Each component will be interconnected using jumper cables, which are attached to input/output (I/O) pins on the MQ135 sensor and Wemos D1 R2, allowing the sensor to read and transmit data to the Wemos D1 R2. The arrangement of the input/output (I/O) pins is as follows:

- 1) Pin VCC on MQ-135: Connect the VCC pin on the MQ-135 sensor to the 5V pin on the Wemos D1 R2. This will provide 5V power to the sensor to enable optimal sensor operation.
- 2) Pin GND on MQ-135: Connect the GND pin on the MQ-135 sensor to the GND pin on the Wemos D1 R2. This will establish a common ground for both the sensor and the development board.
- 3) Pin A0 on MQ-135: Connect the A0 pin (analog output) on the MQ-135 sensor to one of the analog input pins on the Wemos D1 R2, such as pin A0. Pin A0 will transmit an analog signal related to the detected gas concentration by the sensor.

III. RESULT AND DISCUSSION

A. Hardware Implementation

The figure below shows that the design and implementation of an IoT-based CO₂ gas level monitoring tool using an MQ135 sensor in the IT Telkom Surabaya environment has been successful in monitoring and measuring CO₂ emissions generated by motorized vehicles

in the campus area for five active days of campus work from Monday to Friday starting from 09.00 WIB to 17.00 WIB.

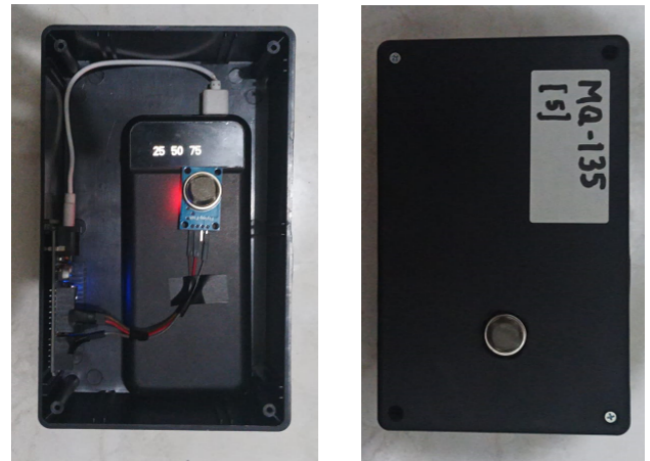

Figure IV. Result of Hardware Design

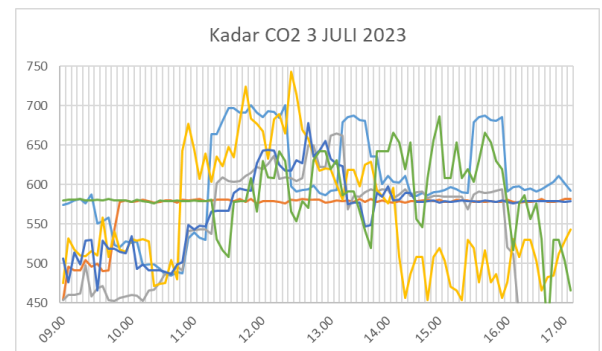

Figure V. Hardware Implementation

B. CO₂ Monitoring Results

The following is an explanation of the results and discussion based on the chart presented.

1) Day 1 Monitoring



2) Day 2 Monitoring

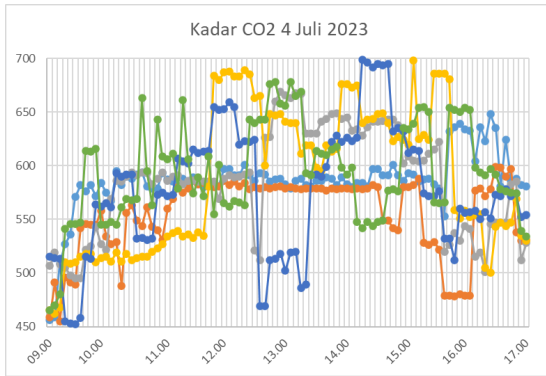

3) Day 3 Monitoring

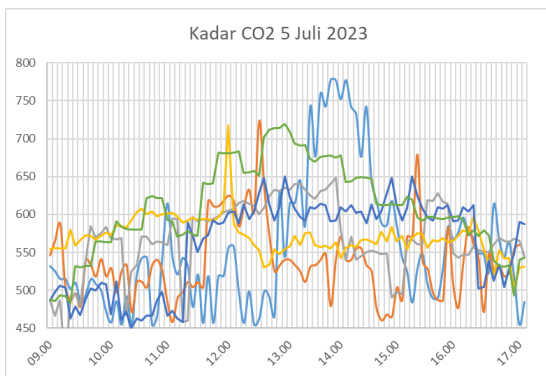

4) Day 4 Monitoring

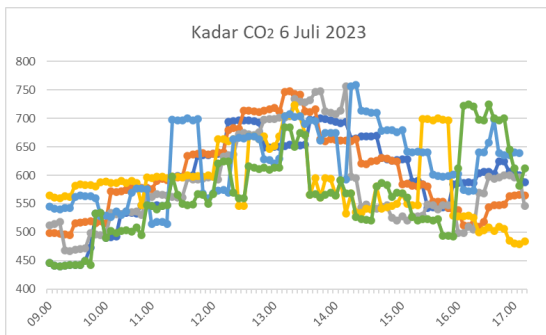

5) Day 5 Monitoring

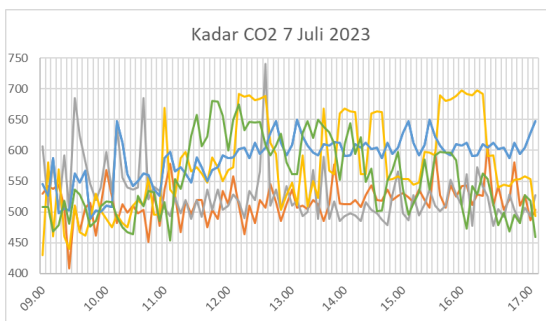

Based on the CO₂ measurements using six MQ-135 sensors simultaneously in the open parking area from Monday to Friday, it can be concluded that in the morning,

the CO₂ levels range between 450-500, which falls within the normal CO₂ range. However, during the daytime, there is an increase in CO₂ levels to 600-700, possibly due to the higher vehicular activity in the parking area. In the afternoon, the CO₂ levels start to decrease, approaching the morning levels within the range of 450-600, although not uniformly across all sensors used in the measurements.

This monitoring outcome offers crucial insights into the daily patterns of CO₂ levels in the open parking area. The finding of increased CO₂ levels around midday might indicate potential environmental issues, particularly concerning vehicle emissions in the ITTelkom Surabaya parking area. Such increases could be attributed to the influx of vehicles entering the parking area and weather conditions. Additionally, temperature changes can restrict air movement and decrease fresh air circulation, contributing to elevated CO₂ concentrations in the vicinity of the parking area.

Based on the observations, action is necessary to mitigate CO₂ emissions. Moreover, these measurement results can serve as reference data for planning a more efficient and environmentally friendly parking area layout. For example, optimizing land use by allocating additional parking space or implementing green technologies in parking area construction. Thus, this study provides an understanding of the CO₂ level patterns in the open parking area during specific times and serves as a basis for taking appropriate measures to reduce CO₂ emissions and improve air quality in the parking area.

C. Analysis Results

1) Tree Density Calculation Results

Based on the data analysis, it was found that the tree density in the parking area of ITTelkom Surabaya is approximately 0.058 trees per square meter. This result indicates that the tree density in the area is already sufficient. With this tree density result, it can be concluded that the tree planting around ITTelkom Surabaya has been successful, and there is no urgent need to add more trees at this time.

2) Results of Species Diversity Index Analysis

The Shannon-Wiener diversity index was found to be 0.978 in the ITTelkom Surabaya parking lot. An index value close to 1 indicates that the ecosystem at that location has a low level of species diversity. With this level of diversity, the diversity of plant species in the parking area needs to be increased so that it can be considered more stable and has a good resistance to environmental changes.

3) Tree CO₂ Absorption Analysis Results

The results of the calculation of the total CO₂ absorption capacity of 191.44 grams / hour show that the open area analyzed has a significant ability

to absorb carbon dioxide (CO₂) from the air. The CO₂ absorption value that reaches 191.44 grams / hour indicates that this open area has a good potential in reducing CO₂ levels in the ITTelkom Surabaya parking area, especially considering the average range of CO₂ levels of around 500 - 600 ppm which if converted into grams / hour is in the range of 150 - 190 grams / hour.

4) Analysis Result of Calculation of Remaining CO₂ Absorption Capacity

The results of the calculation of residual CO₂ emissions show variations in CO₂ absorption at various levels of CO₂ levels per hour. Where in the previous calculation it was obtained if the total absorption capacity in the ITTelkom Surabaya parking area was 191.44gram per hour. The following is an explanation of the analysis results in the ITTelkom Surabaya parking area:

Waktu	Kadar Gas Emisi CO ₂ (gr/jam)	Sisa Daya Serap(gr/jam)
09.00	155	36,44
10.00	157	34,44
11.00	179	12,44
12.00	185	6,44
13.00	179	12,44
14.00	172	19,44
15.00	173	18,44
16.00	160	31,44

Table I. CO₂ Emission Residual Result Day 1

Waktu	Kadar Gas Emisi CO ₂ (gr/jam)	Sisa Daya Serap(gr/jam)
09.00	153	38,44
10.00	166	25,44
11.00	174	17,44
12.00	180	11,44
13.00	179	12,44
14.00	182	9,44
15.00	175	16,44
16.00	168	23,44

Table II. CO₂ Emission Residual Result Day 2

Waktu	Kadar Gas Emisi CO ₂ (gr/jam)	Sisa Daya Serap(gr/jam)
09.00	154	37,44
10.00	160	31,44
11.00	167	24,44
12.00	178	13,44
13.00	183	8,44
14.00	176	15,44
15.00	169	22,44
16.00	163	28,44

Table III. CO₂ Emission Residual Result Day 3

Waktu	Kadar Gas Emisi CO ₂ (gr/jam)	Sisa Daya Serap(gr/jam)
09.00	151	40,44
10.00	162	29,44
11.00	176	15,44
12.00	192	-0,56
13.00	200	-8,56
14.00	183	8,44
15.00	171	20,44
16.00	173	18,44

Table IV. CO₂ Emission Residual Result Day 4

Waktu	Kadar Gas Emisi CO ₂ (gr/jam)	Sisa Daya Serap(gr/jam)
09.00	154	37,44
10.00	158	33,44
11.00	165	26,44
12.00	174	17,44
13.00	170	21,44
14.00	168	23,44
15.00	171	20,44
16.00	167	24,44

Table V. CO₂ Emission Residual Result Day 5

From the results of this analysis, it can be concluded that open areas have sufficient CO₂

absorption to offset CO₂ production. Although there is an increase in CO₂ levels per hour, and there are 2 times minus results obtained on the same day. However, there is a positive relationship with the CO₂ absorption efficiency of the area. Therefore, monitoring and management of open areas need to be paid more attention to ensure the sustainability and effectiveness of CO₂ sequestration in the surrounding environment. The results of this analysis provide very important insights for understanding the important role of green open areas in reducing CO₂ levels in the ITTelkom Surabaya parking area.

5) Results of Average CO₂ Absorption Estimation Analysis

The study found an estimated average CO₂ absorption rate of 0.498 grams/m²/hour in the ITTelkom Surabaya open area. This indicates sufficient CO₂ absorption efficiency for an environment with an average CO₂ concentration of 500 - 600 ppm, or about 150 - 200 grams/hour. The obtained estimate suggests a positive impact on lowering CO₂ concentration. In conclusion, the study highlights the potential of the ITTelkom Surabaya open area to effectively absorb CO₂ through its vegetation, especially trees. This finding can guide sustainable environmental management efforts.

IV. CONCLUSIONS

In the context of designing and implementing an IoT-based CO₂ gas monitoring device using the MQ135 sensor in the ITTelkom Surabaya environment, several key findings need to be highlighted:

- 1) The CO₂ measurement data in the ITTelkom Surabaya parking area indicates a consistent pattern over the initial four observation days, with an increase in CO₂ concentration during the daytime and a decrease in the evening. However, on Fridays, a notable shift in the pattern is observed, possibly due to higher vehicular activities before the weekend. This underscores the influence of daily activities on CO₂ emissions.
- 2) The analysis results reveal that the total CO₂ absorption capacity by trees in the green open space reaches 191.44 grams/hour, with an average CO₂ absorption rate of 0.498 grams/m²/hour. Despite a calculated low tree density (0.058 trees/m²), the area successfully manages to absorb CO₂ emissions with a significant surplus absorption capacity (20.36 gr/hour). These findings illustrate the environment's efficacy in reducing CO₂ emissions through green open spaces.
- 3) Although the Shannon-Wiener biodiversity index indicates a low level of diversity, this doesn't diminish the area's effectiveness in CO₂ absorption. However, the potential for enhanced CO₂ absorption can be further leveraged by

planting more trees in the ITTelkom Surabaya parking area. Hence, the preservation and development of green open spaces become crucial for maintaining air quality and the environment within the ITTelkom Surabaya vicinity.

ACKNOWLEDGMENT

All academicians of Institut Teknologi Telkom Surabaya.

REFERENCES

- [1] [1] Ismiyati, I., Marlita, D., & Saidah, D. (2014). Pencemaran Udara Akibat Emisi Gas Buang Kendaraan Bermotor. *Jurnal Manajemen Transportasi & Logistik (JMTRANSLOG)*, 1(3), 241. <https://doi.org/10.54324/j.mtl.v1i3.23>
- [2] Roshintha, R. R., & Mangkoedihardjo, S. (2016). Analisis Kecukupan ruang Terbuka Hijau sebagai penyerap emisi gas Karbon Dioksida (CO₂) Pada Kawasan Kampus its Sukoliko, Surabaya. *Jurnal Teknik ITS*, 5(2). <https://doi.org/10.12962/j23373539.v5i2.17510>
- [3] Jati, H. A., & Lelono, D. (2013, Oktober). Deteksi dan monitoring polusi udara berbasis array. Dipetik Juli 24, 2017, dari <http://download.portalgaruda.org/article.php?article=149425&val=304&titleDeteksi%20dan%20Monitoring%20Polusi%20Udara%20Berbasis%20Arra%20Sensor%20Gas>.
- [4] Rochmania, A., Suchyo, I., & Yantidewi, M. (2021). Monitoring Kandungan CO₂ Berbasis IOT Dengan Nodemcu ESP8266 Dan Sensor MQ135. *Jurnal Sains Dan Pendidikan Fisika*, 17(3), 249. <https://doi.org/10.35580/jspf.v17i3.30634>
- [5] Prakoso, A. D., & Wellem, T. (2022). Perancangan Dan Implementasi Sistem Pemantauan Kualitas udara berbasis IOT Menggunakan Wemos D1 Mini Dan Android. *Building of Informatics, Technology and Science (BITS)*, 4(3). <https://doi.org/10.47065/bits.v4i3.2498>
- [6] Sai, K. B., Subbareddy, S. R., & Luhach, A. K. (2019). IOT based air quality monitoring system using MQ135 and MQ7 with analysis. *Scalable Computing: Practice and Experience*, 20(4), 599–606. <https://doi.org/10.12694/scpe.v20i4.1561>
- [7] Marisha, S. (2018). Analisis Kemampuan Pohon Dalam Menyerap CO₂ Dan Menyimpan Karbon Pada Jalur Hijau Jalan Di Sub Wilayah Kota Tegalega, Kota Bandung. Skripsi Sarjana Institut Teknologi Bandung
- [8] Walpole, R.E., Myers, R.H., Myers, S.L., Ye, K. 2012. *Probability & Statistics for Engineers and Scientists*. Ninth ed. Amerika: Pearson Education. [Online] Available at: http://www.kpbb.org/makalah_ind/Emisi%20Gas%20Buang%20Bermotor%20%26%20Dampaknya%20Terhadap%20Kesehatan.pdf
- [9] Tugaswati, T. 2012. Emisi Gas Buang Kendaraan Bermotor dan Dampaknya Terhadap Kesehatan.
- [10] Soedomo, M. (2001). Pencemaran udara: kumpulan karya ilmiah. Penerbit ITB.
- [11] Chaniago, D., Zahara, A., & Ramadhani, I. S. (2020, September 24). INDEKS STANDAR PENCEMAR UDARA (ISPU) SEBAGAI INFORMASI MUTU UDARA AMBIEN DI INDONESIA. Portal direktorat pengendalian pencemaran Udara Ditjen PPKL KLHK. Retrieved December 19, 2022, from <https://ditppu.menlhk.go.id/portal/read/indeks-standar-pencemar-udara-ispu-sebagai-informasi-mutu-udara-ambien-di-indonesia>
- [12] Setiadi, D., & Abdul Muhaemin, M. N. (2018). Penerapan internet of things (IOT) pada sistem monitoring IR-IGASI (smart Irigasi). *Infotronik : Jurnal Teknologi Informasi Dan Elektronika*, 3(2), 95. <https://doi.org/10.32897/infotronik.2018.3.2.108>
- [13] M. Zikri and R. Khair, "Rancang Bangun Monitoring Polusi Udara Berbasis Arduino," *J. Teknovasi*, vol. 05, no. 01, pp. 27–38, 2018, [Online]. Available: <http://ejournal.plm.ac.id/index.php/Teknovasi/article/view/205/pdf>.
- [14] Divisi Digital Service, "ANTARES | Reliable IoT Platform," PT Telekomunikasi Indonesia, 04 2017. [Online]. Available: <https://www.antares.id/docs.html>. [Accessed 19 07 2023].
- [15] Averagevalue. AverageValue - Arduino Reference. (n.d.). <https://www.arduino.cc/reference/en/libraries/averagevalue/>. [Accessed 19 07 2023].
- [16] Hanwei Electronics Co.,LTD MQ-135 [http://www.hwsensor.com/technical ...](http://www.hwsensor.com/technical...) (n.d.). https://www.electronicoscaldas.com/datasheet/MQ-135_Hanwei.pdf [Accessed 15 08 2023].
- [17] Rosa, A. A., Simon, B. A., & Lieanto, K. S. (2020). Sistem Pendeteksi pencemaran udara portabel Menggunakan sensor MQ-7 Dan MQ-135. *Ultima Computing : Jurnal Sistem Komputer*, 12(1), 23–28. <https://doi.org/10.31937/sk.v12i1.1611>
- [18] Setyowati, D. (2008). Iklim Mikro dan Kebutuhan Ruang Terbuka Hijau di Kota Semarang. *Jurnal Manusia dan Lingkungan*, 15(3): 125-140.
- [19] Odum, E. (1993). *Dasar-Dasar Ekologi*. Edisi Ketiga. Yogyakarta: Gajah Mada University
- [20] Suryani, Y. A. Damayanti. (2014). Analisis Kemampuan Jalur Hijau Jalan sebagai Ruang Terbuka Hijau (RTH) Publik untuk Menyerap Emisi Karbon Monoksida (CO) dari Kendaraan Bermotor di Kecamatan Genteng Surabaya. Seminar Nasional Pemanfaatan Mata Air Umbulan untuk Kemakmuran Rakyat