

# Design Of A Portable Soil Fertility Mapping Tool Based On IOT

1<sup>st</sup> Budhi Priambodo  
Faculty of Information Technology and  
Business  
Institut Teknologi Telkom Surabaya  
Surabaya, Indonesia  
budhii@student.itelkom-sby.ac.id

2<sup>nd</sup> Helmy Widyantara  
Faculty of Information Technology and  
Business  
Institut Teknologi Telkom Surabaya  
Surabaya, Indonesia  
helmywid@ittelkom-sby.ac.id

3<sup>rd</sup> Khodijah Amiroh  
Faculty of Information Technology and  
Business  
Institut Teknologi Telkom Surabaya  
Surabaya, Indonesia  
dijaamiroh@ittelkom-sby.ac.id

**Abstract**— *Indonesia is an agricultural country, a country where part of the economic life comes from agriculture. Where the main capital needed in this sector is land. But each region has different soil characteristics. On that basis, the author designed a portable tool that can help the government and related agencies in mapping the level of soil fertility at the most efficient cost possible. Soil fertility sensors are already available on the market, these sensors are able to detect Nitrogen, Phosphorus, and Potassium levels of an agricultural land, but at a fairly expensive price. One of the innovations in information and communication technology in agriculture is the use of the Internet of Things. With the Internet of Things, this portable sensor can be accessed through a device anywhere without having to visit a field. So on that basis, the author designed a tool that can help the government and related agencies in determining the level of soil fertility in a land and the tool provides advice on planting the right plants on the land. With this portable tool, officers can also sample soil levels along with land coordinates and send them directly to the cloud. By storing soil fertility data in the cloud, it allows related agencies to map agricultural land with suitable plants, so that optimal results can be obtained. The test results show that the tool made is able to function properly. The NPK sensor successfully detects the level of soil fertility with 100% accuracy, and the NEO7M GPS module is able to accurately transmit land location coordinates. Soil fertility data and land coordinates were successfully processed and displayed in a user-friendly website. Through mapping in ArcGIS, lands with different fertility levels were identified and visualized.*

**Keywords**—Soil fertility, NPK Sensor, IOT

## I. INTRODUCTION

In the modern era, technological advancements have significantly impacted various aspects of human life, including the agricultural sector. One notable innovation is the application of the Internet of Things (IoT), which enables electronic devices to communicate and share information through the internet network[1]. The implementation of IoT in agriculture, known as Agri-IoT, has opened new opportunities for monitoring and optimizing agricultural processes, including the monitoring and analysis of soil conditions[2].

Soil fertility is a crucial factor in agriculture, as it determines the quality and yield of crops. To understand the level of soil fertility, measurements of various nutrient elements such as Nitrogen (N), Phosphorus (P), and Potassium (K) present in the soil are essential[3][4]. In an effort to enhance the efficiency and accuracy of soil fertility monitoring, this research focuses on the development of a portable soil fertility mapping device based on IoT.

Essentially, this device is designed to measure soil fertility levels based on NPK nutrient elements and also accurately identify the location of land through a GPS module. The data generated by this device will be processed and presented in the form of a web interface, allowing farmers or relevant parties to monitor soil fertility conditions and land locations more easily[5].

In the initial stages, this research will present the fundamental concept of the IoT and its contributions to the agricultural world. Subsequently, explanations regarding the portable soil fertility mapping device and the components used will be outlined. Following that, the research methodology used in the device development will be detailed, including functional testing and land mapping using the ArcGIS software. Moreover, the research findings and conclusions will be elucidated, along with suggestions for further research.

Through the development of this portable soil fertility mapping device based on IoT, it is anticipated to make a positive contribution to the optimization of modern agricultural practices. With more accurate and easily accessible monitoring capabilities, farmers are expected to make more informed decisions in managing agricultural land, ultimately leading to increased productivity and quality of crop yields.

## II. METHODS

### A. Diagram Block

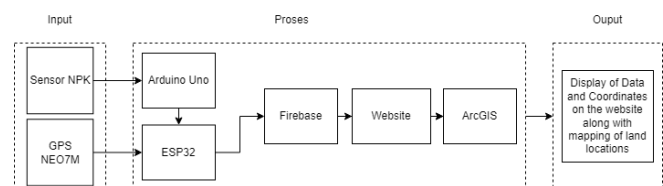

Figure 1. Diagram Block System

The input from the NPK sensor provides data to the Arduino Uno microcontroller for processing. Furthermore, Arduino Uno and NEO7M GPS module provide data to ESP32 to be uploaded using Wi-Fi to Firebase. The created website show the test result data in the form of Nitrogen, Phosphorus, Potassium and land coordinates. All inputs and results will be monitored using the website that has been created. Then the land data will be mapped using ArcGIS.

### B. Hardware Design

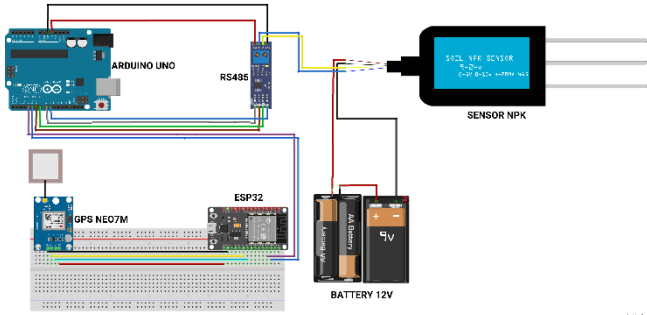

Figure II. Wiring Diagram System

Arduino Uno microcontroller, ESP32, NPK sensor, NEO7M GPS, RS485, 12volt battery is the hardware design of the internet of things-based soil fertility mapping tool design. Figure II. Shows the hardware design of the design of the internet of things-based soil fertility mapping tool. Arduino Uno microcontroller as a controller between devices. ESP32 microcontroller which is used to send data from Arduino Uno and NEO7M GPS to firebase. NPK sensor as a sensor to determine the level of soil fertility. GPS NEO7M which is used to determine the coordinate location of a land. RS485 as a module for sending data from the NPK sensor to the Arduino Uno microcontroller. 12v battery which is designed in series as a power source for the NPK sensor.

### C. Flowchart System

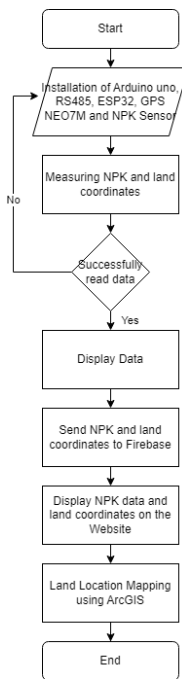

Figure II. Flowchart Diagram System

## III. RESULT AND DISCUSSION

### A. Hardware Implementation

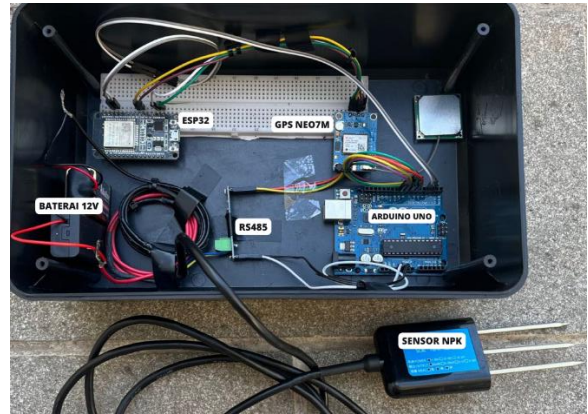

Figure III. Hardware

The following shows a picture of all components of the design of the Internet of Things (IoT)-based soil fertility mapping tool which is contained by a box measuring 24.2 cm x 11.8 cm x 14.6 cm. The hardware components used in this research include Arduino Uno and ESP32 as microcontrollers and data senders to firebase, RS485 as a data transfer from the NPK sensor to the Arduino Uno microcontroller, GPS NEO7M as a gps for taking land location coordinates, 12V battery as a voltage source for the NPK sensor and 3000 mAh powerbank as a power source for the microcontroller.

### B. NPK Sensor

NPK sensor testing is carried out to detect soil fertility in the form of Nitrogen, Posphor, and Potassium in a field. Testing was carried out at 15.00 WIB - 17.30 WIB. This test is carried out after the NEO7M GPS module receives a signal from the satellite. from the satellite. The following is a table of soil fertility results that have been tested:

Land Number	Nitrogen	Posphor	Kalium
Land 1	107	146	105
Land 2	130	39	109
Land 3	138	52	131
Land 4	249	84	73
Land 5	49	67	165
Land 6	81	111	19
Land 7	59	80	199
Land 8	49	67	165
Land 9	107	146	105
Land 10	229	57	6

Table I. Soil Fertility Data

### C. GPS NEO7M

Testing the NEO7M GPS module is carried out to find out whether the GPS module is running properly and can send the location of the land that has been tested for soil fertility.

Land Number	Latitude	Longitude
Land 1	-7.371736	112.714618
Land 2	-7.371856	112.716046
Land 3	-7.372607	112.713518
Land 4	-7.373607	112.715793

Land Number	Latitude	Longitude
Land 5	-7.374180	112.713962
Land 6	-7.374662	112.716082
Land 7	-7.374669	112.716066
Land 8	-7.375548	112.713700

Table II. Land Location Data

#### D. Device Fault Testing

This test was carried out 10 times on the same land with a data transmission time lag of 5 seconds to determine the error rate on the tools that have been made. The results of this test can be seen in the table below.

Number of Trials	Nitrogen	Phospor	Kalium
Trial 1	102	58	114
Trial 2	102	58	114
Trial 3	102	58	114
Trial 4	102	58	114
Trial 5	102	58	114
Trial 6	102	58	114
Trial 7	102	58	114
Trial 8	102	58	114
Trial 9	102	58	114
Trial 10	102	58	114

Table III. NPK Sensor Trials

Number of Trials	Latitude	Longitude
Trial 1	-7.373692	112.714216
Trial 2	-7.373692	112.714216
Trial 3	-7.373692	112.714216
Trial 4	-7.373692	112.714216
Trial 5	-7.373692	112.714216
Trial 6	-7.373692	112.714216
Trial 7	-7.373692	112.714216
Trial 8	-7.373692	112.714216
Trial 9	-7.373692	112.714216
Trial 10	-7.373692	112.714216

Table IV. GPS NEO7M Trials

From the results of 10 tests, it can be seen that the NPK sensor and NEO7M GPS sent the same data 10 times, which means this tool produces 0% error.

#### E. ArcGIS Land Mapping

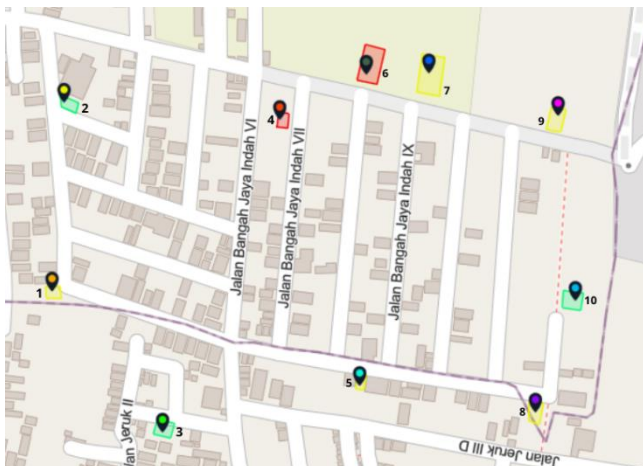

Figure IV. ArcGIS

The following are the results of land mapping that has been tested for soil fertility. From the results of the tests carried out, there are 3 fertile lands, namely land with numbers 2, 3 and 10. Researchers distinguish fertile, medium, and infertile land by giving 3 different colors, namely:

Color	Label	Description
Green	Fertile	Meet the 3 conditions of soil fertility indicators
Yellow	Medium Fertile	Meet the 2 conditions of soil fertility indicators
Red	Infertile	Meets $\leq 1$ soil fertility indicator requirement

Table V. Land Distinguishing Color

#### F. Website Monitoring

The results of data processing from Arduino will produce output data which will be displayed on the website base. In this study the authors used firebase for the database and hoster. Here is one of the applications of the Internet of Things itself.

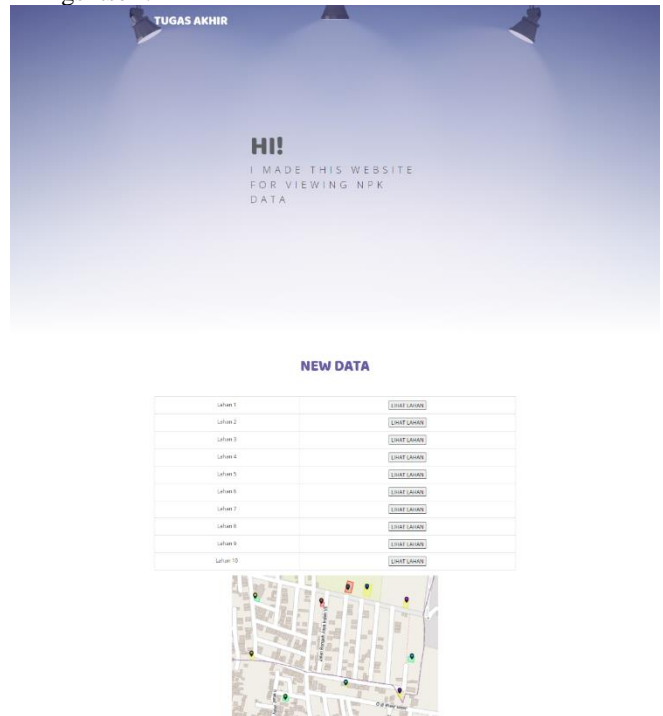

Figure V. HomePage

Figure V. shows the Homepage view of the website that has been created. To see the results of land fertility testing and its location, you can directly click the "VIEW LAND" button in the NEW DATA column, along with ArcGIS land mapping under the new data column.

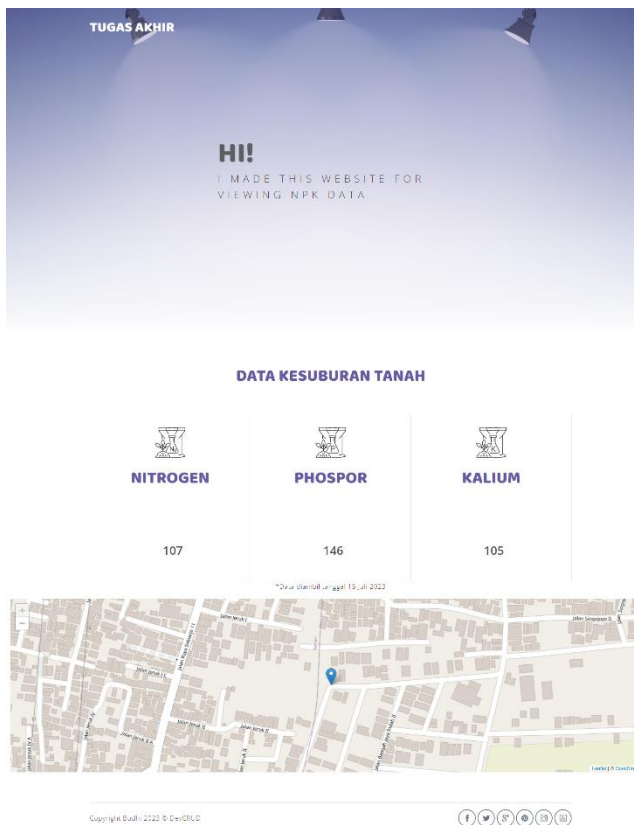

Figure VI. DataPage

The following figure is the monitoring result data containing soil fertility data that has been tested in the form of Nitrogen, Phospor, Potassium and land location coordinates along with the date of soil fertility data collection.

#### IV. CONCLUSIONS

Based on the results of the research that has been carried out, several conclusions can be drawn, namely:

1. From the results of testing the tools made can run well according to plan. However, the NPK sensor must wait for the GPS module to get a signal from the satellite so that it can display the soil fertility value and land location coordinates.
2. The monitoring system can be monitored through a website that can display outputs, namely Nitrogen, Phospor, and Potassium along with the results of land location mapping that has been processed in ArcGIS.
3. The results of soil fertility testing can be concluded that land with numbers 2, 3, 10 which are in the Wage and Bangah areas are fertile land.
4. This portable soil fertility tool can last up to 3 hours using a powerbank of 3000mAh
5. From the results of testing the error of the tool made is 0% error.

#### ACKNOWLEDGMENT

All academicians of Institut Teknologi Telkom Surabaya

#### REFERENCES

- [1] Rahman, M. F., Budiman, F., & Fuadi, A. Z. (2021). *Sistem Monitoring Keadaan Tanah Berbasis IOT*, vol.8, 1039–1049.
- [2] Afandi, H., & Ulum, M. E. R. (2018). *PEMBUATAN PROTOTYPE ALAT UKUR KESUBURAN TANAH BERBASIS ARDUINO UNO*, 160–165
- [3] Arafat, Ratna, S., Wagino, & Ibrahim. (2021). *PERANCANGAN DAN PENGUJIAN ALAT UNTUK MONITORING KELEMBABAN TANAH DAN PEMBERIAN PUPUK CAIR PADA TANAMAN CABAI BERBASIS INTERNET Of THINGS*, vol.12, 287.
- [4] Iwan. (2016). *Sistem Pendeteksi Tingkat Kesuburan Tanah untuk Menentukan Tingkat Perbandingan Penggunaan Pupuk Organik dan Anorganik pada Lahan Pertanian Menggunakan Arduino*, 21-23.
- [3] Sinambela, L. E. P. D., Mahmudin, A., & Auliasari, K. (2020). *PENERAPAN IoT (Internet of Thing) TERHADAP SISTEM PENDETEKSI KESUBURAN TANAH PADA LAHAN PERKEBUNAN*, Vol.4 No.2, 207–213.